



Drainage and Erosion Control

EROSION CONTROL



STRAW WADDLE

SKU	DESCRIPTION	SIZE	QUANTITY	PALLET DEPOSIT
020897	STRAW WADDLE	9" x 25' ROLL	14 ROLLS/PALLET	NONE
140209	WOOD STAKES	1" x 2" x 18"	50 PCS./BNDL.	NONE

- **STRAW FIBER ROLLS THAT CONTROL EROSION BY CAPTURING SEDIMENT AND SPREADING WATER RUN-OFF**
- **MADE OF 100% NATURAL STRAW FIBERS**



JUTE MESH

SKU	DESCRIPTION	SIZE	QUANTITY	PALLET DEPOSIT
021220	JUTE MESH	4' x 225' ROLL	15 ROLLS/PALLET	NONE
021222	LANDSCAPING STAPLES	6"	1000 PCS./CASE	NONE

- **BIODEGRADABLE, OPEN WEAVE, EROSION CONTROL MATTING**
- **THE WEAVE OPENINGS ACT AS TINY CHECK DAMS, WHICH INHIBIT THE SPEED OF WATER RUN-OFF AND KEEP THE SOIL IN PLACE**

SILT FENCE

SKU	DESCRIPTION	SIZE	QUANTITY	PALLET DEPOSIT
021200	SILT FENCE	3' x 100' ROLL	50 ROLLS/PALLET	NONE

- **POLY FIBER FENCING THAT CONTROLS EROSION BY CAPTURING SEDIMENT AND SPREADING WATER RUN-OFF**
- **STAKED EVERY 10'**

SAND BAGS

SKU	DESCRIPTION	SIZE	QUANTITY	PALLET DEPOSIT
020892	FILLED POLY SANDBAG	14" x 26"	70 BAGS/PALLET	\$10.00
020893	EMPTY POLY SANDBAG	14" x 26"	1000 BAGS/PALLET	NONE
020894	EMPTY BURLAP SANDBAG	14" x 26"	1000 BAGS/PALLET	NONE

- **POLY FIBER OR BURLAP SANDBAGS FOR GENERAL EROSION CONTROL**
- **IDEAL FOR BLOCKING AND CONTROLLING WATER FLOW**
- **POLY FIBER SANDBAGS ARE UV RATED AT 1600 HOURS**

CONSTRUCTION ZONE DRAIN PIPE

TRIPLE WALL™ DRAINAGE PIPE

SKU	DESCRIPTION	SIZE	QUANTITY	PALLET DEPOSIT
150303	3" DRAINAGE PIPE - SOLID	3" x 10'	130 PCS./PALLET	NONE
150306	3" DRAINAGE PIPE - PERF.	3" x 10'	130 PCS./PALLET	NONE
150309	4" DRAINAGE PIPE - SOLID	4" x 10'	90 PCS./PALLET	NONE
150312	4" DRAINAGE PIPE - PERF.	4" x 10'	90 PCS./PALLET	NONE
150315	6" DRAINAGE PIPE - SOLID	6" x 10'	40 PCS./PALLET	NONE
150318	6" DRAINAGE PIPE - PERF.	6" x 10'	40 PCS./PALLET	NONE

- **TRIPLE WALL PIPE IS IDEAL FOR CHANNELING STORM WATER RUN-OFF**
- **FOR USE IN GRAVITY FLOW DRAINAGE AND LEECH FIELD APPLICATIONS**
- **MEETS ASTM F-810**



SDR 35 DRAINAGE PIPE

SKU	DESCRIPTION	SIZE	QUANTITY	PALLET DEPOSIT
150208	3" SDR PIPE - SOLID	3" x 10'	95 PCS./PALLET	NONE
150210	3" SDR PIPE - PERF.	3" x 10'	95 PCS./PALLET	NONE
150213	4" SDR PIPE - SOLID	4" x 10'	84 PCS./PALLET	NONE
150214	4" SDR PIPE - PERF.	4" x 10'	84 PCS./PALLET	NONE
150221	6" SDR PIPE - SOLID	6" x 10'	26 PCS./PALLET	NONE
150222	6" SDR PIPE - PERF.	6" x 10'	26 PCS./PALLET	NONE

- **SDR STANDS FOR STANDARD DIMENSION RATIO**
- **SDR PIPE IS CONSIDERED PVC PIPE**
- **SDR PIPE CAN BE SOLVENTLY GLUED**
- **MEETS ASTM D-2729**

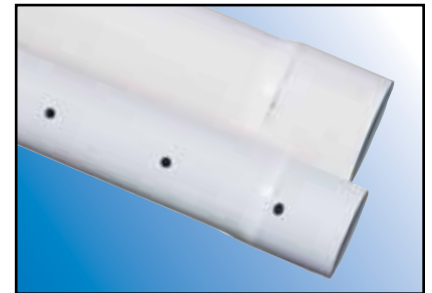

DRAIN SLEEVE

SKU	DESCRIPTION	SIZE	QUANTITY	PALLET DEPOSIT
021020	DRAIN SLEEVE	4" x 100'	18 ROLLS/CASE	NONE

- **FABRIC TUBE THAT EASILY SLIPS OVER DRAIN PIPE**
- **PREVENTS DIRT AND DEBRIS FROM CLOGGING WEEP HOLES, BUT ALLOWS WATER TO FLOW THROUGH**

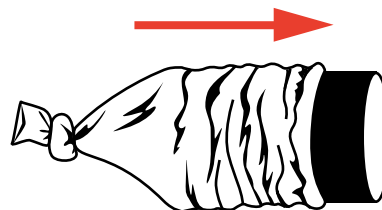

**DRAIN SLEEVE EASILY
SLIPS OVER DRAIN PIPE**

ORDER NOW! 1-800-325-6851

CONSTRUCTION ZONE

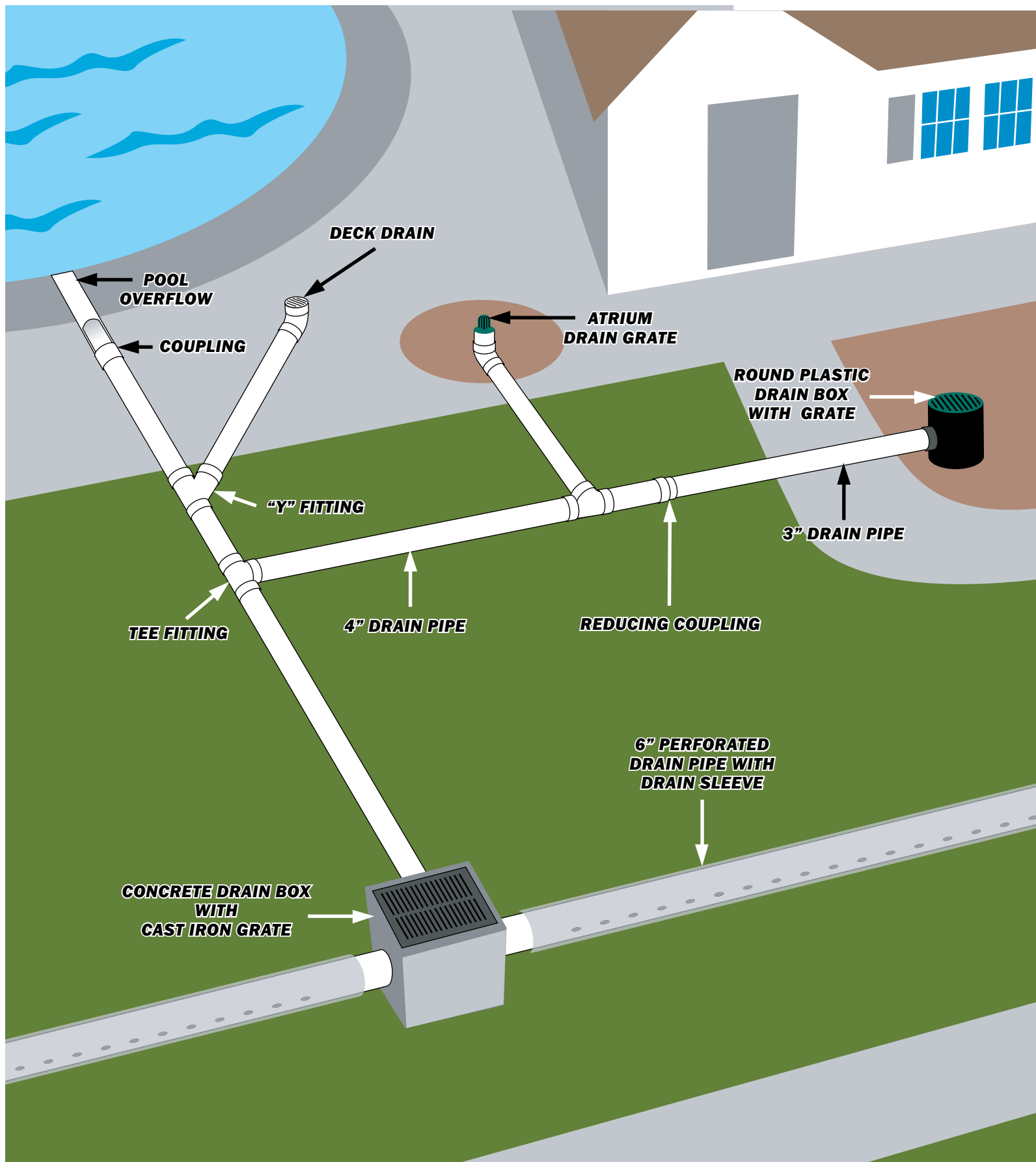

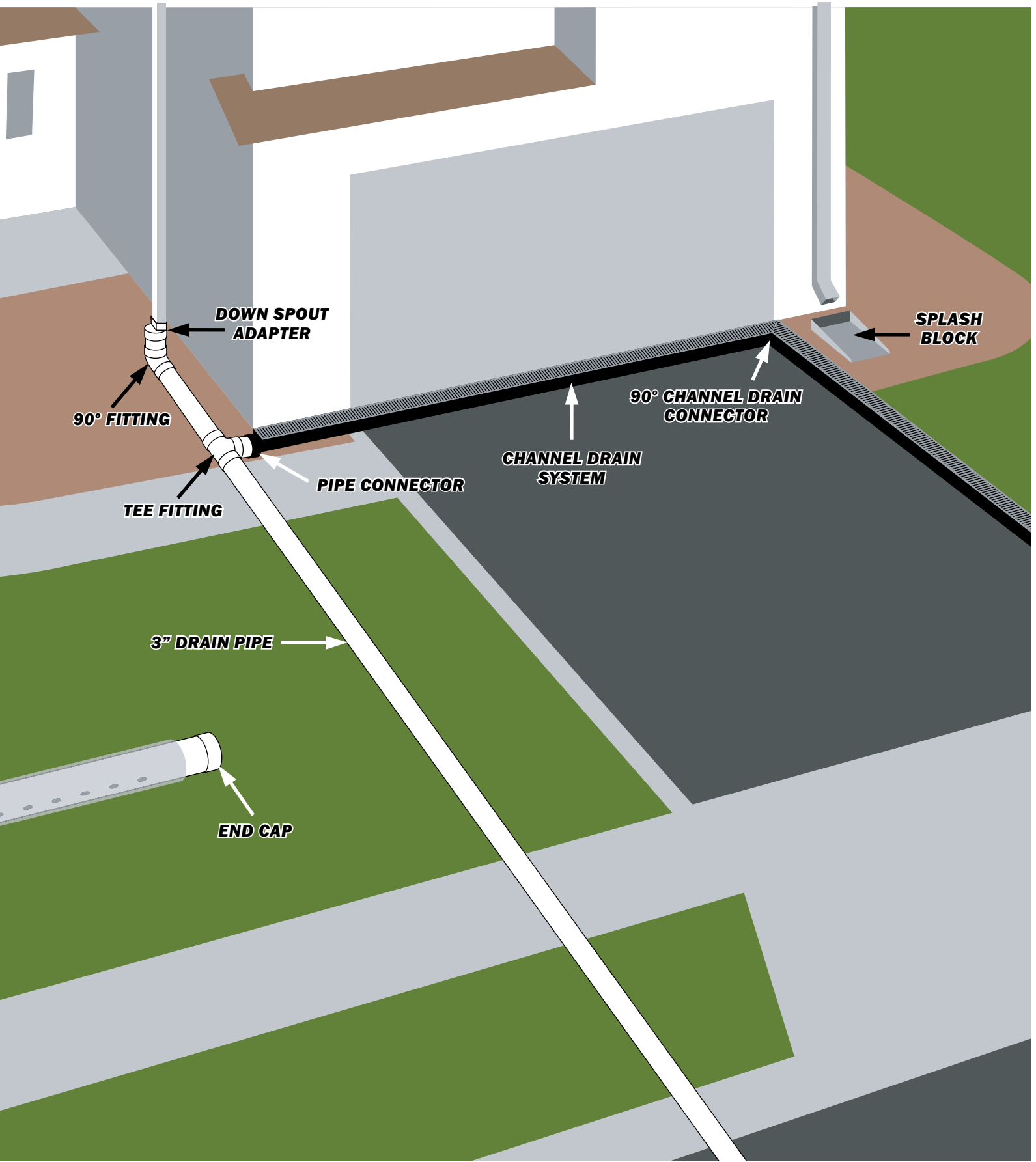

ORDER NOW! 1-800-325-6851

PIPE FITTINGS



90° ELBOW (1/4 BEND)

SKU	DESCRIPTION	SIZE	QUANTITY	PALLET DEPOSIT
150363PVC	3" 90° PVC ELBOW	3"	25 PCS./CASE	NONE
150366PVC	4" 90° PVC ELBOW	4"	24 PCS./CASE	NONE
150369PVC	6" 90° PVC ELBOW	6"	8 PCS./CASE	NONE

- 3" FITTINGS MEET ASTM D-2729
- 4" AND 6" FITTINGS MEET ASTM D-3034 AND CSA B-182.1
- PVC FITTINGS CAN BE SOLVENT WELDED TO SDR 35 PIPE



45° ELBOW (1/8 BEND)

SKU	DESCRIPTION	SIZE	QUANTITY	PALLET DEPOSIT
150339PVC	3" 45° PVC ELBOW	3"	60 PCS./CASE	NONE
150342PVC	4" 45° PVC ELBOW	4"	30 PCS./CASE	NONE
150345PVC	6" 45° PVC ELBOW	6"	12 PCS./CASE	NONE

- 3" FITTINGS MEET ASTM D-2729
- 4" AND 6" FITTINGS MEET ASTM D-3034 AND CSA B-182.1
- PVC FITTINGS CAN BE SOLVENT WELDED TO SDR 35 PIPE



22° ELBOW (1/16 BEND)

SKU	DESCRIPTION	SIZE	QUANTITY	PALLET DEPOSIT
150372PVC	3" 22° PVC ELBOW	3"	13 PCS./CASE	NONE
150375PVC	4" 22° PVC ELBOW	4"	45 PCS./CASE	NONE
150382PVC	6" 22° PVC ELBOW	6"	10 PCS./CASE	NONE

- 3" FITTINGS MEET ASTM D-2729
- 4" AND 6" FITTINGS MEET ASTM D-3034 AND CSA B-182.1
- PVC FITTINGS CAN BE SOLVENT WELDED TO SDR 35 PIPE



LONGTURN ELBOW

SKU	DESCRIPTION	SIZE	QUANTITY	PALLET DEPOSIT
150407PVC	3" PVC LONGTURN ELBOW	3"	20 PCS./CASE	NONE
150408PVC	4" PVC LONGTURN ELBOW	4"	20 PCS./CASE	NONE
150410PVC	6" PVC LONGTURN ELBOW	6"	6 PCS./CASE	NONE

- 3" FITTINGS MEET ASTM D-2729
- 4" AND 6" FITTINGS MEET ASTM D-3034 AND CSA B-182.1
- PVC FITTINGS CAN BE SOLVENT WELDED TO SDR 35 PIPE

PIPE FITTINGS

TEE FITTING

SKU	DESCRIPTION	SIZE	QUANTITY	PALLET DEPOSIT
150330PVC	3" PVC TEE FITTING	3"	30 PCS./CASE	NONE
150333PVC	4" PVC TEE FITTING	4"	20 PCS./CASE	NONE
150336PVC	6" PVC TEE FITTING	6"	6 PCS./CASE	NONE

- **3" FITTINGS MEET ASTM D-2729**
- **4" AND 6" FITTINGS MEET ASTM D-3034 AND CSA B-182.1**
- **PVC FITTINGS CAN BE SOLVENT WELDED TO SDR 35 PIPE**



SANITARY TEE

SKU	DESCRIPTION	SIZE	QUANTITY	PALLET DEPOSIT
150384PVC	3" PVC SANITARY TEE	3"	30 PCS./CASE	NONE
150386PVC	4" PVC SANITARY TEE	4"	18 PCS./CASE	NONE
150389PVC	6" PVC SANITARY TEE	6"	4 PCS./CASE	NONE

- **3" FITTINGS MEET ASTM D-2729**
- **4" AND 6" FITTINGS MEET ASTM D-3034 AND CSA B-182.1**
- **PVC FITTINGS CAN BE SOLVENT WELDED TO SDR 35 PIPE**



"Y" FITTING

SKU	DESCRIPTION	SIZE	QUANTITY	PALLET DEPOSIT
150374PVC	3" PVC "Y" FITTING	3"	25 PCS./CASE	NONE
150377PVC	4" PVC "Y" FITTING	4"	16 PCS./CASE	NONE
150383PVC	6" PVC "Y" FITTING	6"	4 PCS./CASE	NONE

- **3" FITTINGS MEET ASTM D-2729**
- **4" AND 6" FITTINGS MEET ASTM D-3034 AND CSA B-182.1**
- **PVC FITTINGS CAN BE SOLVENT WELDED TO SDR 35 PIPE**



COUPLING

SKU	DESCRIPTION	SIZE	QUANTITY	PALLET DEPOSIT
150321PVC	3" PVC COUPLING	3"	40 PCS./CASE	NONE
150324PVC	4" PVC COUPLING	4"	36 PCS./CASE	NONE
150327PVC	6" PVC COUPLING	6"	18 PCS./CASE	NONE

- **3" FITTINGS MEET ASTM D-2729**
- **4" AND 6" FITTINGS MEET ASTM D-3034 AND CSA B-182.1**
- **PVC FITTINGS CAN BE SOLVENT WELDED TO SDR 35 PIPE**



ORDER NOW! 1-800-325-6851

PIPE FITTINGS

END CAP



SKU	DESCRIPTION	SIZE	QUANTITY	PALLET DEPOSIT
150322PVC	3" PVC END CAP	3"	100 PCS./CASE	NONE
150351PVC	4" PVC END CAP	4"	20 PCS./CASE	NONE
150354PVC	6" PVC END CAP	6"	24 PCS./CASE	NONE

- 3" FITTINGS MEET ASTM D-2729
- 4" AND 6" FITTINGS MEET ASTM D-3034 AND CSA B-182.1
- PVC FITTINGS CAN BE SOLVENT WELDED TO SDR 35 PIPE



REDUCER

SKU	DESCRIPTION	QUANTITY	PALLET DEPOSIT
150395PVC	4" x 3" PVC REDUCER	55 PCS./CASE	NONE
150393PVC	6" x 4" PVC REDUCER	27 PCS./CASE	NONE

- 3" FITTINGS MEET ASTM D-2729
- 4" AND 6" FITTINGS MEET ASTM D-3034 AND CSA B-182.1
- PVC FITTINGS CAN BE SOLVENT WELDED TO SDR 35 PIPE

POOL OVERFLOW

SKU	DESCRIPTION	QUANTITY	PALLET DEPOSIT
150901	3" POOL OVERFLOW (WHITE)	12 PCS./CASE	NONE



- PVC PIPE
- MEETS ASTM D-3034
- ATTACHES TO 3" PIPE FITTING
- CAN BE SOLVENT WELDED

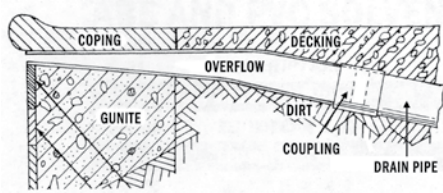

TYPICAL INSTALLATION

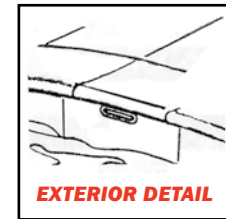

EXTERIOR DETAIL



DOWNSPOUT ADAPTER

SKU	DESCRIPTION	QUANTITY	PALLET DEPOSIT
150378PVC	2" x 3" x 3" ADAPTER	40 PCS./CASE	NONE
150379PVC	3" x 4" x 3" ADAPTER	65 PCS./CASE	NONE
150380PVC	3" x 4" x 4" ADAPTER	60 PCS./CASE	NONE
150381PVC	2" x 3" x 4" ADAPTER	35 PCS./CASE	NONE

PIPE GLUE

PVC SOLVENT CEMENT

SKU	DESCRIPTION	SIZE	QUANTITY	PALLET DEPOSIT
152960	PVCEMENT GLUE - BLUE	1/4 PINT	24/BOX	NONE
152965	PVCEMENT GLUE - BLUE	1/2 PINT	24/BOX	NONE
152967	PVCEMENT GLUE - GRAY	1/2 PINT	24/BOX	NONE
152970	PVCEMENT GLUE - BLUE	1 PINT	24/BOX	NONE
152972	PVCEMENT GLUE - GRAY	1 PINT	24/BOX	NONE
152975	PVCEMENT GLUE - BLUE	1 QUART	12/BOX	NONE



- **SOLVENT CEMENT FORMULATED TO PROVIDE THE OPTIMUM BALANCE BETWEEN AGGRESSIVE PIPE PENETRATION AND QUICK SET TIME**
- **BLUE IN COLOR TO SHOW QUANTITY APPLIED**
- **EXCELLENT GAP-FILLING CAPABILITY**
- **SUITABLE FOR POTABLE WATER, DWV, SEWER, CONDUIT, SPRINKLER, POOL, SPA, AND FLEX-VINYL APPLICATIONS**
- **OKAY FOR USE IN WET OR DRY CONDITIONS**
- **NO PRIMER IS REQUIRED WITH PVCEMENT BLUE GLUE , BUT YOU MAY NEED IT TO MEET CODE APPROVAL**
- **GRAY GLUE IS SPECIALLY FORMULATED FOR USE WITH GRAY CONDUIT**

750 HOTWELD™

PALLET

SKU	DESCRIPTION	SIZE	QUANTITY	DEPOSIT
153002	750 HotWeld	1/4 Pint	24/BOX	NONE
153004	750 HotWeld	1/2 PINT	24/BOX	NONE
153006	750 HotWeld	1 PINT	24/BOX	NONE
153008	750 HotWeld	1 QUART	12/BOX	NONE

Weld-On 750 is a medium bodied, fast setting PVC solvent cement with superior long-term performance that is excellent for use in challenging conditions including wet, damp or cold applications. In addition, Weld-On 750 is a one-step, Low-VOC formulation that complies with LEED requirements.



ORDER NOW! 1-800-325-6851

DRAIN GRATES



DRAIN GRATES

SKU	DESCRIPTION	QUANTITY	PALLET DEPOSIT
150357PVC	3" DRAIN GRATE	50 PCS./CASE	NONE
150360PVC	4" DRAIN GRATE	30 PCS./CASE	NONE
150361PVC	6" DRAIN GRATE	15 PCS./CASE	NONE

- FITS INTO A PIPE FITTING
- WILL NOT ATTACH DIRECTLY TO PIPE WITHOUT A FITTING
- CAN BE SOLVENT WELDED



TAN COLOR SHOWN

DECK GRATES

SKU	DESCRIPTION	QUANTITY	PALLET DEPOSIT
150355	3" DECK GRATE - WHITE	50 PCS./CASE	NONE
150355G	3" DRAIN GRATE - GRAY	50 PCS./CASE	NONE
150355T	3" DECK GRATE - TAN	50 PCS./CASE	NONE

- REMOVABLE GRATE FOR EASY CLEANING
- DESIGNED TO FIT OVER THE END OF A 3" PIPE - NO FITTING REQUIRED



GREEN COLOR SHOWN

ATRIUM GRATES

SKU	DESCRIPTION	QUANTITY	PALLET DEPOSIT
150512	3" ATRIUM GRATE - GREEN	40 PCS./CASE	NONE
150515	3" ATRIUM GRATE - BLACK	40 PCS./CASE	NONE
150506	4" ATRIUM GRATE - GREEN	40 PCS./CASE	NONE
150509	4" ATRIUM GRATE - BLACK	40 PCS./CASE	NONE
150496	6" ATRIUM GRATE - GREEN	40 PCS./CASE	NONE
150503	6" ATRIUM GRATE - BLACK	40 PCS./CASE	NONE

- ATRIUM GRATES ARE IDEAL FOR HIGH WATER AREAS
- THE DOME PREVENTS LEAVES AND OTHER DEBRIS FROM BLOCKING THE DRAIN
- FITS INTO PIPE OR INTO A FITTING



BRASS DRAIN GRATES

SKU	DESCRIPTION	QUANTITY	PALLET DEPOSIT
150630	3" DRAIN GRATE	20 PCS./CASE	NONE
150636	4" DRAIN GRATE	20 PCS./CASE	NONE
150650	6" DRAIN GRATE	10 PCS./CASE	NONE

- HAS A BRUSHED OR SATIN FINISH
- GRATE HAS 2 SCREWS FOR EASY REMOVAL
- 3" AND 4" GRATES FIT INTO A FITTING
- 6" GRATE FITS INTO A 6" PIPE FITTING OR INTO A ROUND BASIN

DRAIN GRATES

SQUARE POLY GRATE

SKU	DESCRIPTION	QUANTITY	PALLET DEPOSIT
150449	4" SQUARE GRATE - GREEN	10 PCS./CASE	NONE
150450	4" SQUARE GRATE - BLACK	10 PCS./CASE	NONE
150451	6" SQUARE GRATE - BLACK	10 PCS./CASE	NONE
150454	6" SQUARE GRATE - GREEN	10 PCS./CASE	NONE



- FOR USE IN MEDIUM WATER FLOW AREAS
- MADE OF IMPACT RESISTANT MATERIAL
- FITS INTO PIPE OR INTO A FITTING
- ADA COMPLIANT
- USE IN AREAS THAT DO NOT REQUIRE BASIN OR WHERE SPACE DOESN'T ALLOW FOR A BASIN

ROUND POLY GRATE

SKU	DESCRIPTION	QUANTITY	PALLET DEPOSIT
150487	3" ROUND GRATE - BLACK	40 PCS./CASE	NONE
150493	3" ROUND GRATE - GREEN	40 PCS./CASE	NONE
150478	4" ROUND GRATE - BLACK	40 PCS./CASE	NONE
150484	4" ROUND GRATE - GREEN	40 PCS./CASE	NONE
150472	6" ROUND GRATE - GREEN	10 PCS./CASE	NONE



- 3" AND 4" GRATES FIT INTO A PIPE OR FITTING
- 6" GRATE FITS INTO A 6" PIPE FITTING OR INTO A ROUND BASIN
- MADE OF IMPACT RESISTANT MATERIAL
- ADA COMPLIANT

SQUARE BRASS GRATES

SKU	DESCRIPTION	QUANTITY	PALLET DEPOSIT
150609	5" x 5" BRASS GRATES	10 PCS./CASE	NONE
150612	6" x 6" BRASS GRATES	10 PCS./CASE	NONE



- SOLID CAST BRASS CONSTRUCTION
- 4 SCREWS FOR GRATE REMOVAL
- BOTH STYLES FIT INTO A 4" PIPE FITTING

ROUND BRASS GRATES

SKU	DESCRIPTION	QUANTITY	PALLET DEPOSIT
150618	3" ROUND BRASS GRATE	100 PCS./CASE	NONE
150621	4" ROUND BRASS GRATE	100 PCS./CASE	NONE



- SOLID CAST BRASS CONSTRUCTION
- FITS INTO A PIPE FITTING

CONSTRUCTION ZONE DRAIN BOXES



CONCRETE DRAIN BOX

SKU	DESCRIPTION	QUANTITY	PALLET DEPOSIT
042348	8" CONCRETE DRAIN BOX	48 PCS./PALLET	\$10.00
042354	10" CONCRETE DRAIN BOX	27 PCS./PALLET	\$10.00
042355	12" CONCRETE DRAIN BOX	12 PCS./PALLET	\$10.00
042356	16" CONCRETE DRAIN BOX	1 PCS./PALLET	\$10.00
042358	24" CONCRETE DRAIN BOX	1 PCS./PALLET	\$10.00

- **SOLID CAST CONCRETE BOX**
- **USED TO COLLECT HIGH VOLUME WATER FLOWS FROM YARDS, LAWNS, AND PAVED AREAS**
- **BOX DESIGN ALLOWS SAND AND DIRT TO DROP TO BOTTOM OF BOX FOR EASY CLEAN-UP**
- **WATER RISES TO DRAIN OUT SIDE OUTLET**
- **FOR USE IN PEDESTRIAN AREAS – NOT RATED FOR VEHICLE TRAFFIC**

8" CONCRETE DRAIN BOX

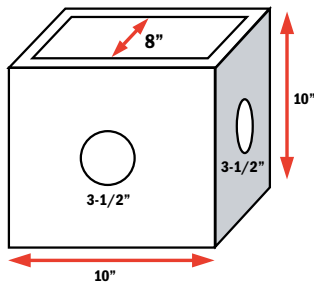

SIDES 1 & 2

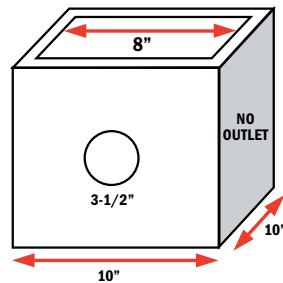

SIDES 3 & 4

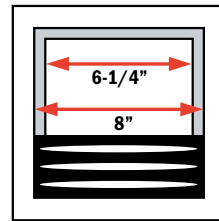

TOP VIEW

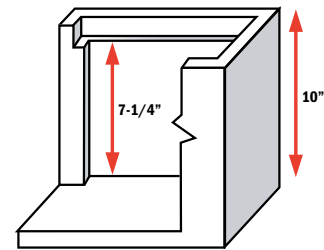

INTERNAL VIEW

10" CONCRETE DRAIN BOX

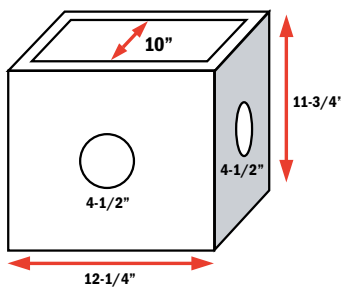

SIDES 1 & 2

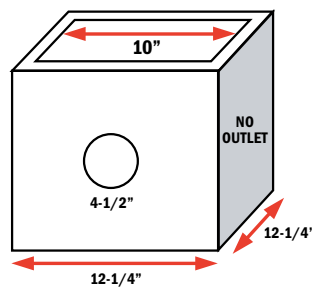

SIDES 3 & 4

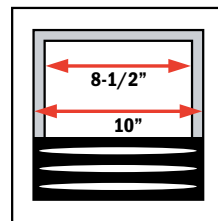

TOP VIEW

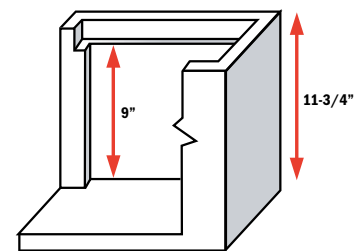

INTERNAL VIEW

CONSTRUCTION ZONE DRAIN BOXES

12" CONCRETE DRAIN BOX

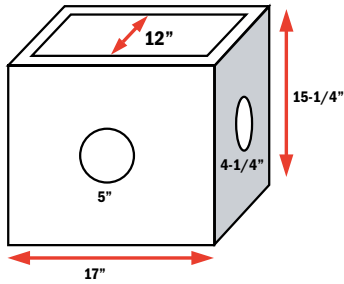

SIDES 1 & 2

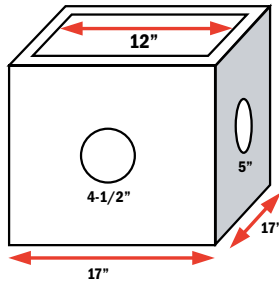

SIDES 3 & 4

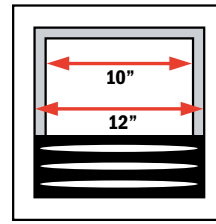

TOP VIEW

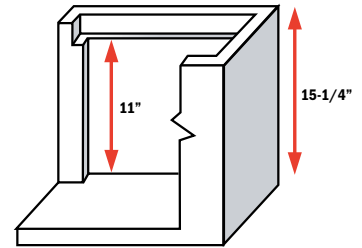

INTERNAL VIEW

16" CONCRETE DRAIN BOX

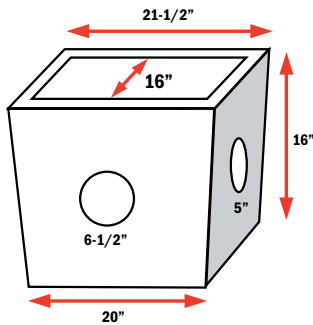

SIDES 1 & 2

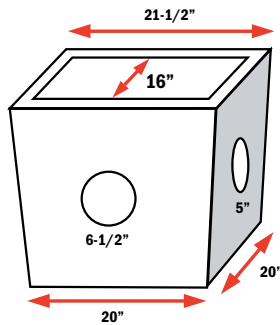

SIDES 3 & 4

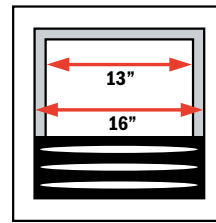

TOP VIEW

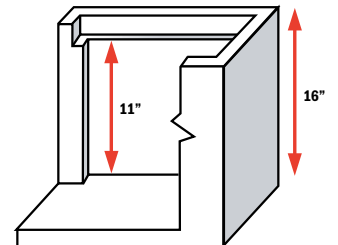

INTERNAL VIEW

24" CONCRETE DRAIN BOX

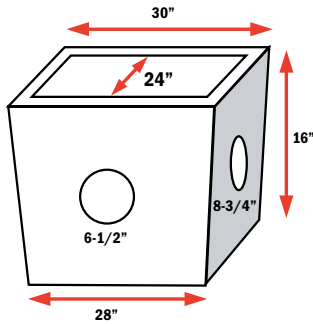

SIDES 1 & 2

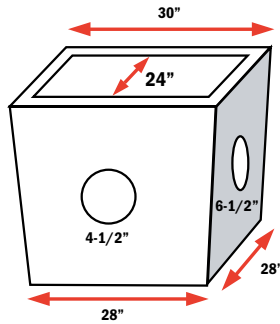

SIDES 3 & 4

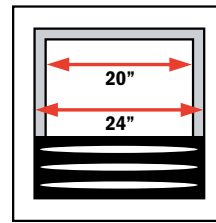

TOP VIEW

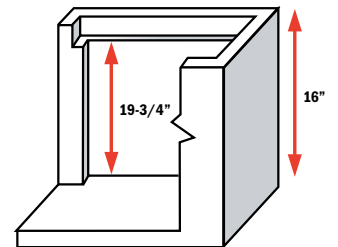

INTERNAL VIEW



STEP ONE:
USE A HAMMER TO GENTLY
KNOCK OUT THE OUTLETS
YOU PLAN TO USE.



STEP TWO:
FIT DRAIN PIPE INTO THE
OUTLET.



STEP THREE:
USE A GROUT OR MORTAR
TO CEMENT THE DRAIN
PIPE IN PLACE.



STEP FOUR:
PLACE THE DRAIN GRATE
ON TOP.

ORDER NOW! 1-800-325-6851

DRAIN GRATES AND FRAMES

CAST IRON DRAIN GRATE

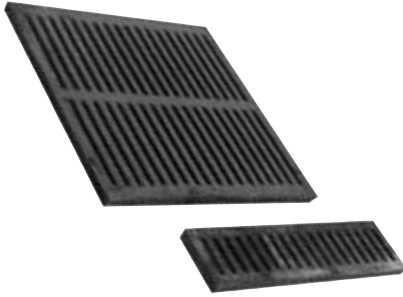

SKU	DESCRIPTION	GRATE THICKNESS	PALLET DEPOSIT
150518	6" x 6" CAST IRON GRATE	5/8"	NONE
150527	8" x 8" CAST IRON GRATE	11/16"	NONE
150536	10" x 10" CAST IRON GRATE	7/8"	NONE
150545	12" x 12" CAST IRON GRATE	11/16"	NONE
150554	16" x 16" CAST IRON GRATE	15/16"	NONE
150563	18" x 18" CAST IRON GRATE	11/16"	NONE
150572	24" x 24" CAST IRON GRATE	15/16"	NONE
150581	6" x 24" CAST IRON GRATE	15/16"	NONE
150584	8" x 24" CAST IRON GRATE	15/16"	NONE
150587	12" x 24" CAST IRON GRATE	7/8"	NONE

- **HEAVY DUTY CAST IRON**
- **SLOTTED TO ALLOW WATER TO DRAIN THROUGH**
- **FOR USE IN PEDESTRIAN AREAS – NOT RATED FOR VEHICLE TRAFFIC**

CAST IRON FRAME



SKU	DESCRIPTION	PALLET DEPOSIT
150521	6" x 6" CAST IRON FRAME	NONE
150530	8" x 8" CAST IRON FRAME	NONE
150539	10" x 10" CAST IRON FRAME	NONE
150548	12" x 12" CAST IRON FRAME	NONE
150557	16" x 16" CAST IRON FRAME	NONE
150566	18" x 18" CAST IRON FRAME	NONE
150575	24" x 24" CAST IRON FRAME	NONE

- **HEAVY DUTY CAST IRON**
- **DESIGNED TO BE SET INTO WET CEMENT**
- **FOR USE IN PEDESTRIAN AREAS – NOT RATED FOR VEHICLE TRAFFIC**

PLASTIC DRAIN BASINS

ROUND BASIN

SKU	DESCRIPTION	QUANTITY	PALLET DEPOSIT
150427	ROUND BASIN - SINGLE OUTLET	12 PCS./CASE	NONE
150430	ROUND BASIN - DOUBLE OUTLET	10 PCS./CASE	NONE

- **SIDE OUTLETS CONNECT TO 3" OR 4" PIPE**
- **TOP INLET ACCEPTS 6" GRATES OR 6" PIPE**

SINGLE OUTLET BASIN



DOUBLE OUTLET BASIN



ROUND DRAIN GRATE

SKU	DESCRIPTION	QUANTITY	PALLET DEPOSIT
150472	6" ROUND POLY GRATE - GREEN	10 PCS./CASE	NONE
150650	6" ROUND BRASS DRAIN GRATE	10 PCS./CASE	NONE

- **ADA COMPLIANT**



POLY GRATE



BRASS GRATE

PLASTIC DRAIN BASINS

SQUARE GRATE

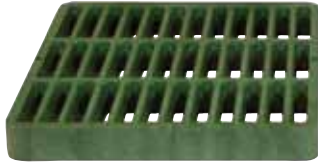

SKU	DESCRIPTION	QUANTITY	PALLET DEPOSIT
150418	9" x 9" SQUARE GRATE - BLACK	10 PCS./CASE	NONE
150421	9" x 9" SQUARE GRATE - GREEN	10 PCS./CASE	NONE
150426	12" x 12" SQUARE GRATE - BLACK	10 PCS./CASE	NONE
150425	12" x 12" SQUARE GRATE - GREEN	10 PCS./CASE	NONE

- **STRONG, IMPACT RESISTANT DRAIN BASIN GRATE**
- **NON-SKID FINISH**
- **ADA COMPLIANT**

ATRIUM GRATE



SKU	DESCRIPTION	QUANTITY	PALLET DEPOSIT
150495.8	9" x 9" ATRIUM GRATE - BLACK	10 PCS./CASE	NONE
150495.6	9" x 9" ATRIUM GRATE - GREEN	10 PCS./CASE	NONE
150495.4	12" x 12" ATRIUM GRATE - BLACK	10 PCS./CASE	NONE
150495.2	12" x 12" ATRIUM GRATE - GREEN	10 PCS./CASE	NONE

- **DOME-SHAPED DRAIN GRATE THAT PREVENTS DEBRIS AND LEAVES FROM BLOCKING WATER FLOW**
- **MADE OF STRONG, IMPACT RESISTANT MATERIAL**

SIDE-OUTLET BASIN



SKU	DESCRIPTION	QUANTITY	PALLET DEPOSIT
150409	9" x 9" SIDE-OUTLET BASIN	10 PCS./CASE	NONE
150517	12" x 12" SIDE-OUTLET BASIN	10 PCS./CASE	NONE

- **SQUARE DRAIN BOX WITH 2 SIDE OUTLETS**
- **MADE OF STRONG, IMPACT RESISTANT MATERIAL**

BASIN OUTLET ADAPTER



SKU	DESCRIPTION	QUANTITY	PALLET DEPOSIT
150415	BASIN OUTLET ADAPTER	10 PCS./CASE	NONE

- **USED TO CONNECT THE DRAIN BASIN TO A DRAINAGE PIPE OR LEACH LINE**
- **CONNECTS TO 3" OR 4" PIPE**

PLASTIC DRAIN BASINS

BASIN PLUG

SKU	DESCRIPTION	QUANTITY	PALLET DEPOSIT
150412	BASIN PLUG	10 PCS./CASE	NONE



• STANDARD PLUG FOR THE SIDE OUTLET DRAIN BASIN

DRAIN BOX SYSTEM



- 150418 9" x 9" SQUARE GRATE - BLACK
- 150426 12" x 12" SQUARE GRATE - BLACK
- 150421 9" x 9" SQUARE GRATE - GREEN
- 150425 12" x 12" SQUARE GRATE - GREEN

- 150495.8 9" x 9" ATRIUM GRATE - BLACK
- 150495.4 12" x 12" ATRIUM GRATE - BLACK
- 150495.6 9" x 9" ATRIUM GRATE - GREEN
- 150495.2 12" x 12" ATRIUM GRATE - GREEN



- 150409 9" x 9" SIDE-OUTLET BASIN
- 150517 12" x 12" SIDE-OUTLET BASIN

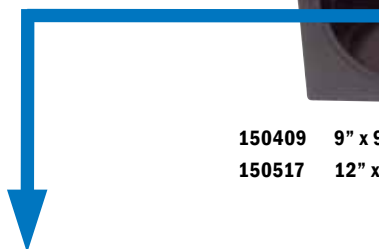

150415 BASIN OUTLET



150415 BASIN OUTLET



150412 BASIN PLUG



150412 BASIN PLUG

ORDER NOW! 1-800-325-6851

CHANNEL DRAIN SYSTEM

CHANNEL DRAIN SYSTEM

- 150666 5" DRAIN GRATE (GREEN) - 2 FT.
- 150668 5" DRAIN GRATE (GRAY) - 2 FT.
- 150670 5" DRAIN GRATE (BLACK) - 2 FT.
- 150672 5" DRAIN GRATE (SAND) - 2 FT.



150660 5" CHANNEL DRAIN - 4 FT.



150676 5" COUPLER - STANDARD
SOLD IN CASE OF 20



150676 5" COUPLER - STANDARD
SOLD IN CASE OF 20



150678 5" COUPLER - SCREEN
SOLD IN CASE OF 20



150662 5" CHANNEL DRAIN WITH BOTTOM OUTLET - 2 FT.



BOTTOM
OUTLET
DETAIL



150678 5" COUPLER - SCREEN
SOLD IN CASE OF 20



150680 END CAP
SOLD IN CASE OF 20



150680 END CAP
SOLD IN CASE OF 20



150682 PIPE CONNECTOR
SOLD IN CASE OF 10



150682 PIPE CONNECTOR
SOLD IN CASE OF 10

CHANNEL DRAIN KIT

KIT INCLUDES: 4 FT. DRAIN CHANNEL WITH BOTTOM OUTLET, BOTTOM OUTLET PLUG, TWO 2 FT. GRATES (GRAY), 1 END CAP, AND 1 STANDARD CONNECTOR.

BOTTOM
OUTLET
DETAIL

150690 CHANNEL DRAIN KIT



150692 90° ELBOW
*INCLUDES GRAY GRATE



150694 45° ANGLE
*INCLUDES GRAY GRATE



150696 TEE
*INCLUDES GRAY GRATE



150698 CROSS
*INCLUDES GRAY GRATE

CHANNEL DRAIN SYSTEM

5" CHANNEL DRAIN

SKU	DESCRIPTION	QUANTITY	PALLET DEPOSIT
150660	4 FT. CHANNEL	6 PCS./CASE	NONE
150662	2 FT. CHANNEL DRAIN WITH BOTTOM OUTLET	12 PCS./CASE	NONE

- **5" WIDE PVC CHANNEL DRAIN BODY**
- **CAN BE SOLVENT WELDED**
- **EASILY CUT TO ANY SIZE**



**BOTTOM
OUTLET
DETAIL**

5" DRAIN GRATE

SKU	DESCRIPTION	QUANTITY	PALLET DEPOSIT
150666	2 FT. DRAIN GRATE – GREEN	12 PCS./CASE	NONE
150668	2 FT. DRAIN GRATE – GRAY	12 PCS./CASE	NONE
150670	2 FT. DRAIN GRATE – BLACK	12 PCS./CASE	NONE
150672	2 FT. DRAIN GRATE – SAND	12 PCS./CASE	NONE

- **IMPACT RESISTANT POLYPROPYLENE CHANNEL GRATES**
- **FITS FLUSH WITH CHANNEL BODY – COVERS BLACK BASIN BODY**
- **ABLE TO WITHSTAND H10 IMPACT LOAD (CAN BE DRIVEN ON BY PASSENGER CARS AND LIGHT DUTY VEHICLES)**
- **NON-SKID FINISH**
- **ADA COMPLIANT**



STANDARD COUPLER

SKU	DESCRIPTION	QUANTITY	PALLET DEPOSIT
150676	STANDARD COUPLER	20 PCS./CASE	NONE

- **A STANDARD COUPLER TO CONNECT TWO SECTIONS OF CHANNEL DRAIN**
- **CAN BE SOLVENT WELDED**



SCREEN COUPLER

SKU	DESCRIPTION	QUANTITY	PALLET DEPOSIT
150678	SCREEN COUPLER	20 PCS./CASE	NONE

- **A COUPLER WITH A SCREEN TO PREVENT LEAVES AND OTHER LARGE DEBRIS FROM FLOWING THROUGH**
- **CAN BE SOLVENT WELDED**



CHANNEL DRAIN SYSTEM



END CAP

SKU	DESCRIPTION	QUANTITY	PALLET DEPOSIT
150680	END CAP	20 PCS./CASE	NONE

- A FITTING THAT PLUGS THE END OF THE CHANNEL DRAIN SYSTEM
- CAN BE SOLVENT WELDED



PIPE CONNECTOR

SKU	DESCRIPTION	QUANTITY	PALLET DEPOSIT
150682	PIPE CONNECTOR	10/CASE	NONE

- A COUPLING THAT ALLOWS THE CHANNEL DRAIN SYSTEM TO CONNECT TO A DRAIN PIPE OR LEECH LINE
- CAN BE SOLVENT WELDED



90° ELBOW

SKU	DESCRIPTION	PALLET DEPOSIT
150692	90° ELBOW – INCLUDES GRAY GRATE	NONE

- AN ANGLE CONNECTOR FOR THE CHANNEL DRAIN SYSTEM
- SAVES TIME ON THE JOBSITE
- CLEAN ANGLE
- CAN BE SOLVENT WELDED



45° ELBOW

SKU	DESCRIPTION	PALLET DEPOSIT
150694	45° ELBOW– INCLUDES GRAY GRATE	NONE

- AN ANGLE CONNECTOR FOR THE CHANNEL DRAIN SYSTEM
- SAVES TIME ON THE JOBSITE
- CLEAN ANGLE
- CAN BE SOLVENT WELDED

CHANNEL DRAIN SYSTEM

TEE

SKU	DESCRIPTION	PALLET DEPOSIT
150696	TEE – INCLUDES GRAY GRATE	NONE

- 3-WAY CONNECTOR FOR THE CHANNEL DRAIN SYSTEM
- SAVES TIME ON THE JOBSITE
- CLEAN ANGLE
- CAN BE SOLVENT WELDED



CROSS

SKU	DESCRIPTION	PALLET DEPOSIT
150698	CROSS – INCLUDES GRAY GRATE	NONE

- 4-WAY CONNECTOR FOR THE CHANNEL DRAIN SYSTEM
- SAVES TIME ON THE JOBSITE
- CLEAN ANGLE
- CAN BE SOLVENT WELDED



CHANNEL DRAIN KIT

SKU	DESCRIPTION	PALLET DEPOSIT
150690	CHANNEL DRAIN KIT	NONE

- KIT INCLUDES: 4 FT. DRAIN CHANNEL WITH BOTTOM OUTLET, BOTTOM OUTLET PLUG, TWO 2 FT. GRATES (GRAY), 1 END CAP, AND 1 STANDARD CONNECTOR
- CAN BE SOLVENT WELDED



BOTTOM
OUTLET
DETAIL



DRAINAGE ACCESSORIES

ROLLED POLY



SKU	DESCRIPTION	QUANTITY	PALLET DEPOSIT
020263	4' x 50' 4 MIL – BLACK	288 PCS./PALLET	NONE
020309	10' x 50' 4 MIL – CLEAR	72 PCS./PALLET	NONE
020315	10' x 50' 4 MIL – BLACK	72 PCS./PALLET	NONE
020321	10' x 100' 4 MIL – CLEAR	56 PCS./PALLET	NONE
020327	10' x 100' 4 MIL – BLACK	56 PCS./PALLET	NONE
020333	12' x 100' 4 MIL – CLEAR	49 PCS./PALLET	NONE
020369	20' x 50' 4 MIL – CLEAR	56 PCS./PALLET	NONE
020381	20' x 100' 4 MIL – CLEAR	25 PCS./PALLET	NONE
020387	20' x 100' 4 MIL – BLACK	25 PCS./PALLET	NONE
020415	6' x 100' 6 MIL – BLACK	72 PCS./PALLET	NONE
020433	10' x 50' 6 MIL – CLEAR	72 PCS./PALLET	NONE
020439	10' x 50' 6 MIL – BLACK	72 PCS./PALLET	NONE
020445	10' x 100' 6 MIL – CLEAR	48 PCS./PALLET	NONE
020451	10' x 100' 6 MIL – BLACK	48 PCS./PALLET	NONE
020457	12' x 100' 6 MIL – CLEAR	36 PCS./PALLET	NONE
020463	12' x 100' 6 MIL – BLACK	36 PCS./PALLET	NONE
020481	20' x 50' 6 MIL – CLEAR	48 PCS./PALLET	NONE
020487	20' x 50' 6 MIL – BLACK	48 PCS./PALLET	NONE
020493	20' x 100' 6 MIL – CLEAR	16 PCS./PALLET	NONE
020503	20' x 100' 6 MIL – BLACK	16 PCS./PALLET	NONE
020533	20' x 100' 10 MIL – CLEAR	9 PCS./PALLET	NONE
020539	20' x 100' 10 MIL – BLACK	9 PCS./PALLET	NONES

- **BLACK POLY IS UV RESISTANT – IDEAL FOR OUTDOOR APPLICATIONS!**
- **6 MIL POLY IS IDEALLY SUITED TO WEATHERPROOFING AND WATER PROTECTION TO PREVENT EROSION**

CONCRETE SPLASH BLOCK



SKU	DESCRIPTION	QUANTITY	PALLET DEPOSIT
042360	24" SPLASH BLOCK	60 PCS./PALLET	\$10.00
042363	30" SPLASH BLOCK	30 PCS./PALLET	\$10.00

- **CHANNELS DOWNSPOUT WATER AWAY FROM THE HOUSE**
- **SPLASH BLOCK IS 11" WIDE**