



Concrete Finishing and Paving

FORMING

POLY



SKU	DESCRIPTION	QUANTITY	PALLET DEPOSIT
020493	20' x 100' CLEAR POLY 6 MIL	16 ROLLS/PALLET	NONE
020503	20' x 100' BLACK POLY 6 MIL	16 ROLLS/PALLET	NONE
020533	20' x 100' CLEAR POLY 10 MIL	9 ROLLS/PALLET	NONE
020539	20' x 100' BLACK POLY 10 MIL	9 ROLLS/PALLET	NONE

- **6 AND 10 MIL POLY ARE USED AS A MOISTURE BARRIER UNDER CONCRETE SLABS**
PLEASE CHECK YOUR LOCAL BUILDING CODES
FOR COMPLETE LIST OF POLY PRODUCTS, SEE THE **POLY AND PACKAGING** SECTION

ECOFORM

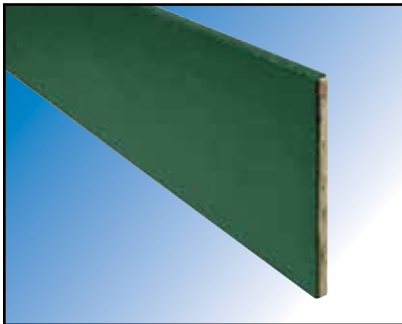

SKU	DESCRIPTION	QUANTITY	PALLET DEPOSIT
030500	3/8" x 3-3/8" x 12' ECOFORM	420 PCS./PALLET	NONE
030504	3/8" x 5-1/2" x 12' ECOFORM	270 PCS./PALLET	NONE

- **REUSABLE LUMBER FOR CONCRETE FORMWORK**
- **PLASTIC COATING RESISTS MOISTURE AND PREVENTS WARPING**
- **ABLE TO FORM TIGHT, UNIFORM BENDS WITHOUT SPLINTERING**
- **CUTS, NAILS, AND STAKES LIKE REGULAR LUMBER**
- **CONCRETE DOES NOT STICK TO ECO-FORM – NO FORM OIL NEEDED!**

FOR MORE INFORMATION SEE www.ecoform1.com/pages/products.php

REDWOOD BENDER BOARD



SKU	DESCRIPTION	SIZE	QUANTITY BUNDLE	QUANTITY PALLET	PALLET DEPOSIT
030257	REDWOOD BENDER BOARD	4" x 10'	10 PCS./BNDL.	96 BNDL./PALL.	NONE
030258	REDWOOD BENDER BOARD	4" x 12'	10 PCS./BNDL.	96 BNDL./PALL.	NONE
030260	REDWOOD BENDER BOARD	4" x 14'	10 PCS./BNDL.	96 BNDL./PALL.	NONE
030260.25	REDWOOD BENDER BOARD	4" x 16'	10 PCS./BNDL.	96 BNDL./PALL.	NONE
030261	REDWOOD BENDER BOARD	4" x 20'	10 PCS./BNDL.	96 BNDL./PALL.	NONE

- **REDWOOD IS LIGHT-WEIGHT, STRONG AND HAS NO MESSY SAP**
- **REDWOOD RESISTS WARPING**
- **FOR CONCRETE FORMWORK OR LANDSCAPING**



ECOFORM BENDER BOARD



REDWOOD BENDER BOARD

FORM STAKES

WOOD STAKES

SKU	DESCRIPTION	BUNDLE QUANTITY	PALLET QUANTITY	PALLET DEPOSIT
140203	1" x 2" x 12" WOOD STAKES	50 PCS./BNDL.	100 BNDL./PALLET	NONE
140209	1" x 2" x 18" WOOD STAKES	50 PCS./BNDL.	50 BNDL./PALLET	NONE
140215	1" x 2" x 24" WOOD STAKES	50 PCS./BNDL.	50 BNDL./PALLET	NONE
140221	1" x 2" x 30" WOOD STAKES	50 PCS./BNDL.	50 BNDL./PALLET	NONE
140227	1" x 2" x 36" WOOD STAKES	50 PCS./BNDL.	50 BNDL./PALLET	NONE
140233	1" x 3" x 12" WOOD STAKES	50 PCS./BNDL.	75 BNDL./PALLET	NONE
140239	1" x 3" x 18" WOOD STAKES	50 PCS./BNDL.	50 BNDL./PALLET	NONE
140245	1" x 3" x 24" WOOD STAKES	50 PCS./BNDL.	50 BNDL./PALLET	NONE
140251	1" x 3" x 30" WOOD STAKES	50 PCS./BNDL.	50 BNDL./PALLET	NONE
140257	1" x 3" x 36" WOOD STAKES	50 PCS./BNDL.	50 BNDL./PALLET	NONE
140269	1" x 3" x 48" WOOD STAKES	50 PCS./BNDL.	50 BNDL./PALLET	NONE



- **IDEAL FOR BRACING BENDER BOARD IN PLACE FOR CONCRETE FORMWORK**
- **GOOD FOR HOLDING POLY SHEETING IN PLACE**
- **VARIETY OF SIZES AVAILABLE**
- **PALLET QUANTITIES MAY VARY**

MARKER LATH

SKU	DESCRIPTION	QUANTITY	PALLET DEPOSIT
140293	48" MARKER LATH	50 PCS./BNDL.	NONE



- **USED BY SURVEYORS AND BUILDERS TO INDICATE IMPORTANT CONSTRUCTION PLAN FEATURES SUCH AS PROPERTY LINES, CUTS, FILLS, INTERSECTIONS, CORNERS, AND MUCH MORE**

FLAT STEEL STAKES

SKU	DESCRIPTION	BUNDLE QUANTITY	PALLET QUANTITY	PALLET DEPOSIT
140303	12" FLAT STEEL STAKES	10 PCS./BNDL.	60 BNDL./PALLET	NONE
140309	18" FLAT STEEL STAKES	10 PCS./BNDL.	60 BNDL./PALLET	NONE
140315	24" FLAT STEEL STAKES	10 PCS./BNDL.	60 BNDL./PALLET	NONE
140321	30" FLAT STEEL STAKES	10 PCS./BNDL.	60 BNDL./PALLET	NONE
140327	36" FLAT STEEL STAKES	10 PCS./BNDL.	60 BNDL./PALLET	NONE
140339	48" FLAT STEEL STAKES	10 PCS./BNDL.	60 BNDL./PALLET	NONE



- **IDEAL FOR BRACING FORM BOARDS**
- **GOOD FOR HOLDING POLY SHEETING IN PLACE**
- **PRE-DRILLED NAIL HOLES FOR EASE OF USE**
- **VARIETY OF SIZES AVAILABLE**

ORDER NOW! 1-800-325-6851

FORM STAKES

ROUND STEEL STAKES

SKU	DESCRIPTION	BUNDLE QUANTITY	PALLET QUANTITY	PALLET DEPOSIT
140345	12" ROUND STEEL STAKES	10 PCS./BNDL.	60 BNDL./PALLET	NONE
140351	18" ROUND STEEL STAKES	10 PCS./BNDL.	60 BNDL./PALLET	NONE
140357	24" ROUND STEEL STAKES	10 PCS./BNDL.	60 BNDL./PALLET	NONE
140363	30" ROUND STEEL STAKES	10 PCS./BNDL.	60 BNDL./PALLET	NONE
140369	36" ROUND STEEL STAKES	10 PCS./BNDL.	60 BNDL./PALLET	NONE
140381	48" ROUND STEEL STAKES	10 PCS./BNDL.	60 BNDL./PALLET	NONE

- IDEAL FOR BRACING BENDER BOARD IN PLACE FOR CONCRETE FORMWORK
- GOOD FOR HOLDING POLY SHEETING IN PLACE
- PRE-DRILLED NAIL HOLES FOR EASE OF USE
- VARIETY OF SIZES AVAILABLE

FORM TIES AND WEDGES

SKU	DESCRIPTION	QUANTITY	PALLET DEPOSIT
100415	6" FORM TIES #WFT6	250 PCS./CASE	NONE
100418	8" FORM TIES #WFT8	250 PCS./CASE	NONE
100424	12" FORM TIES #WFT12	250 PCS./CASE	NONE
100430	FORM TIE WEDGES	500 PCS./CASE	NONE

- USED TO SUPPORT FORM BOARDS TO PREVENT DEFLECTION
- 18 GA. FORM TIES, 14 GA. WEDGES
- GALVANIZED TO PREVENT RUSTING

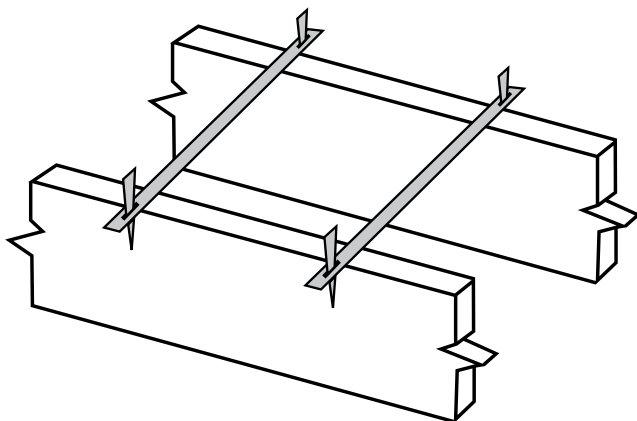

FORM TIES ARE PLACED ACROSS THE FORM BOARDS AND LOCKED IN PLACE WITH FORM TIE WEDGES.

TYPICAL FORM TIE SPACING IS 2' 6" ON 1x NOMINAL FORMS AND 4' ON 2x NOMINAL FORMS.

SCREED HOOKS

FLAT SCREED HOOKS

SKU	DESCRIPTION	QUANTITY	PALLET DEPOSIT
140387	FLAT SCREED HOOKS	50 PCS./CASE	NONE

- SCREED HOOKS HOLD STRING TO HELP YOU KEEP YOUR FORMS LEVEL
- FITS ON FLAT STEEL OR WOOD STAKES
- SET SCREW HOLDS SCREED HOOK FIRMLY IN PLACE
- STURDY STEEL CONSTRUCTION



SINGLE SCREED HOOKS

SKU	DESCRIPTION	QUANTITY	PALLET DEPOSIT
140393	SINGLE SCREED HOOKS	100 PCS./CASE	NONE

- SCREED HOOKS HOLD STRING TO HELP YOU KEEP YOUR FORMS LEVEL
- FITS ON ROUND STEEL STAKES
- SET SCREW HOLDS SCREED HOOK FIRMLY IN PLACE
- STURDY CAST IRON CONSTRUCTION



ORDER NOW! 1-800-325-6851

SCREED HOOKS

DOUBLE SCREED HOOKS



SKU	DESCRIPTION	QUANTITY	PALLET DEPOSIT
140390	DOUBLE SCREED HOOKS	50 PCS./CASE	NONE

- SCREED HOOKS HOLD STRING TO HELP YOU KEEP YOUR FORMS LEVEL
- DOUBLE HOOK ALLOWS YOU TO RUN TWO LEVEL LINES
- FITS ON ROUND STEEL STAKES
- SET SCREW HOLDS SCREED HOOK FIRMLY IN PLACE
- STURDY CAST IRON CONSTRUCTION



WIRE SCREED HOOKS



SKU	DESCRIPTION	QUANTITY	PALLET DEPOSIT
140396	WIRE SCREED HOOKS	100 PCS./CASE	NONE

- SCREED HOOKS HOLD STRING TO HELP YOU KEEP YOUR FORMS LEVEL
- UNIQUE DESIGN FITS BOTH FLAT AND ROUND STAKES
- PINCH-FIT DESIGN ALLOWS ADJUSTMENTS TO BE MADE QUICKLY
- STURDY STEEL CONSTRUCTION

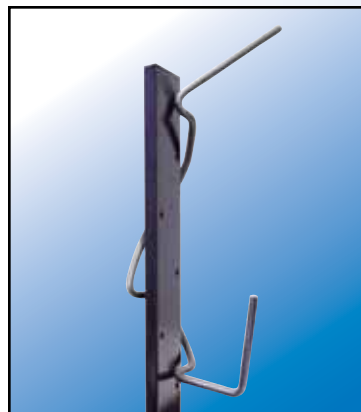

ACCESSORIES

DUPLEX NAILS

SKU	DESCRIPTION	QUANTITY	PALLET DEPOSIT
061978	6D DUPLEX NAILS - 50 LBS.	48 BOXES/PALLET	NONE
061987	8D DUPLEX NAILS - 50 LBS.	48 BOXES/PALLET	NONE
062009	16D DUPLEX NAILS - 50 LBS.	48 BOXES/PALLET	NONE

- FOR TEMPORARY CONSTRUCTION WHERE NAIL REMOVAL IS REQUIRED SUCH AS CONCRETE FRAME WORK, SCAFFOLDS, AND BRACING
- ALSO USED FOR STRINGING TEMPORARY WIRING

FOR A COMPLETE LIST OF NAILS WE CARRY SEE THE **FASTENERS AND FRAMING** SECTION.

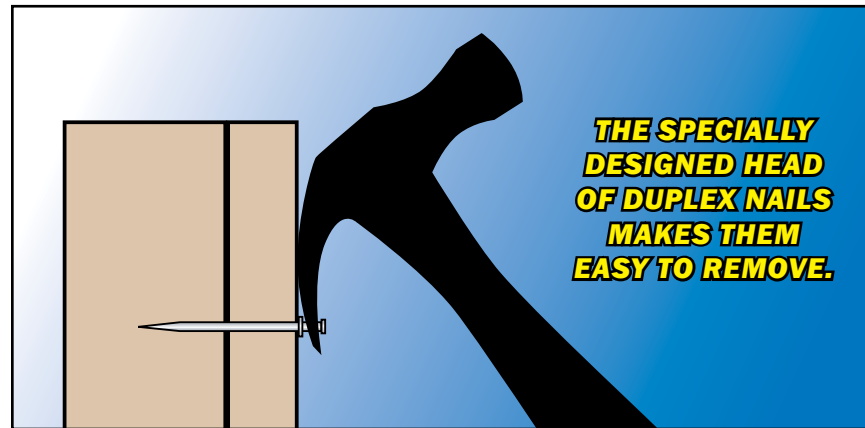

CONSTRUCTION TUBES

SKU	DESCRIPTION	LENGTH	PALLET DEPOSIT
100563	6" CONSTRUCTION TUBE	12'	NONE
100566	8" CONSTRUCTION TUBE	12'	NONE
100569	10" CONSTRUCTION TUBE	12'	NONE
100572	12" CONSTRUCTION TUBE	12'	NONE
100575	14" CONSTRUCTION TUBE	12'	NONE
100578	16" CONSTRUCTION TUBE	12'	NONE
100581	18" CONSTRUCTION TUBE	12'	NONE
100584	20" CONSTRUCTION TUBE	12'	NONE
100590	24" CONSTRUCTION TUBE	12'	NONE
100593	30" CONSTRUCTION TUBE	12'	NONE
100596	36" CONSTRUCTION TUBE	12'	NONE



WHEN YOU BUY A 12 FOOT CONSTRUCTION TUBE, WSW CAN CUT IT TO ANY LENGTH. CUTTING FEE WILL APPLY.

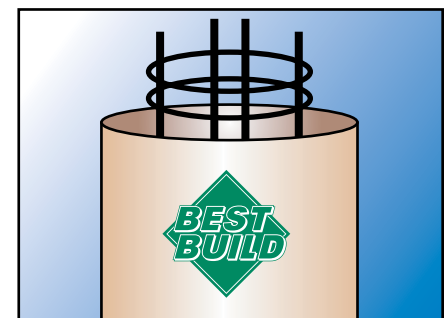

ORDER NOW! 1-800-325-6851

ACCESSORIES

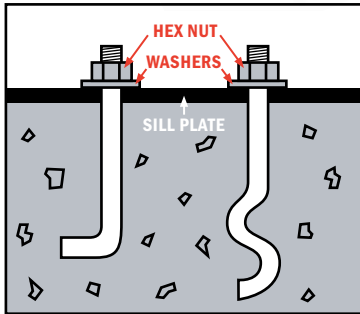

ANCHOR BOLTS

SKU	DESCRIPTION	QUANTITY	PALLET DEPOSIT
062627	1/2" x 6"	100 PCS./BAG	NONE
062633	1/2" x 8"	100 PCS./BAG	NONE
062639	1/2" x 10"	100 PCS./BAG	NONE
062645	1/2" x 12"	100 PCS./BAG	NONE
062651	5/8" x 8"	50 PCS./BAG	NONE
062657	5/8" x 10"	50 PCS./BAG	NONE
062663	5/8" x 12"	50 PCS./BAG	NONE
062665	5/8" x 16"	50 PCS./BAG	NONE
062669	5/8" x 18"	25 PCS./BAG	NONE
062675	3/4" x 8"	50 PCS./BAG	NONE
062681	3/4" x 10"	50 PCS./BAG	NONE
062687	3/4" x 12"	50 PCS./BAG	NONE
062703	3/4" x 16"	25 PCS./BAG	NONE
062709	3/4" x 18"	25 PCS./BAG	NONE

- FOR ATTACHING STRUCTURES TO CONCRETE
- ANGLED END IS EMBEDDED IN CONCRETE LEAVING THREADS EXPOSED
- HEX NUTS INCLUDED IN THE BAG WITH ANCHOR BOLTS



GALVANIZED ANCHOR BOLTS

SKU	DESCRIPTION	QUANTITY	PALLET DEPOSIT
062812	5/8"x12"	100 PCS./BAG	NONE
062814	5/8"x14"	100 PCS./BAG	NONE
062816	5/8"x16"	100 PCS./BAG	NONE
062645	1/2" x 12"	100 PCS./BAG	NONE
062651	5/8" x 8"	100 PCS./BAG	NONE

- FOR ATTACHING BOTTOM PLATE OR SILL PLATE TO NEWLY POURED CONCRETE FOUNDATION
- RECOMMENDED FOR TREATED LUMBER
- ASTM A307 AND ASTM A153 CLASS C

STAB BOLTS

SKU	DESCRIPTION	PALLET DEPOSIT
06STB16	16" STAB BOLT	NONE
06STB20	20" STAB BOLT	NONE
06STB24	24" STAB BOLT	NONE
06STB28	28" STAB BOLT	NONE
06STB34	34" STAB BOLT	NONE
06STB36	36" STAB BOLT	NONE

- FOR ATTACHING STRUCTURES TO CONCRETE
- BENT END IS EMBEDDED IN CONCRETE LEAVING THREADS EXPOSED
- ENGINEERED BENDS PRODUCE SUPERIOR HOLD OVER TRADITIONAL ANCHOR BOLTS

ACCESSORIES

ANCHOR BOLT HOLDERS

SKU	DESCRIPTION	QUANTITY	PALLET DEPOSIT
062763	1/2" BOLT HOLDER	50 PCS./BAG	NONE
062768	5/8" BOLT HOLDER	50 PCS./BAG	NONE
062769	3/4" BOLT HOLDER	50 PCS./BAG	NONE

- A HOLDER DESIGNED TO SUPPORT AN ANCHOR BOLT AND HOLD IT IN POSITION WHILE POURING CONCRETE
- PRE-DRILLED NAIL HOLES
- ATTACH WITH DUPLEX NAILS FOR EASY REMOVAL



ROUND WASHERS

SKU	DESCRIPTION	QUANTITY	PALLET DEPOSIT
062733	1/2" WASHERS	50 LBS./CARTON	NONE
062736	5/8" WASHERS	50 LBS./CARTON	NONE
062739	3/4" WASHERS	50 LBS./CARTON	NONE

- SOME BUILDING CODES REQUIRE SQUARE WASHERS ON ANCHOR BOLTS. PLEASE CHECK YOUR LOCAL BUILDING CODES.



SQUARE WASHERS

SKU	DESCRIPTION	WASHER THICKNESS	QUANTITY	PALLET DEPOSIT
064840	2-1/2" WASHERS 5/8" HOLE	1/4"	250 PCS./CASE	NONE
064844	2-3/4" WASHERS 3/4" HOLE	5/16"	250 PCS./CASE	NONE
064850	3" WASHERS 7/8" HOLE	5/16"	250 PCS./CASE	NONE

- SOME BUILDING CODES REQUIRE SQUARE WASHERS ON ANCHOR BOLTS. PLEASE CHECK YOUR LOCAL BUILDING CODES.



HEX NUTS

SKU	DESCRIPTION	QUANTITY	PALLET DEPOSIT
062748	1/2" HEX NUT	50 LBS./CARTON	NONE
062751	5/8" HEX NUT	50 LBS./CARTON	NONE
062754	3/4" HEX NUT	50 LBS./CARTON	NONE
062757	7/8" HEX NUT	50 LBS./CARTON	NONE



ORDER NOW! 1-800-325-6851

ACCESSORIES

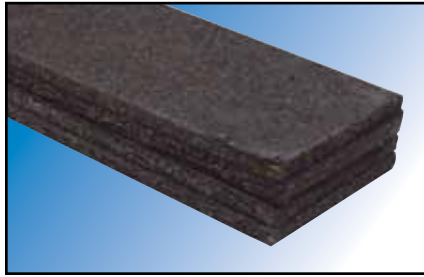

EXPANSION JOINT

SKU	DESCRIPTION	BUNDLE QUANTITY	PALLET QUANTITY	PALLET DEPOSIT
100369	1/2" x 3" EXPANSION JOINT	10 PCS./BNDL.	128 BNDL./PALL.	NONE
100375	1/2" x 3-1/2" EXPANSION JOINT	10 PCS./BNDL.	112 BNDL./PALL.	NONE
100381	1/2" x 4" EXPANSION JOINT	10 PCS./BNDL.	96 BNDL./PALL.	NONE
100387	1/2" x 6" EXPANSION JOINT	10 PCS./BNDL.	64 BNDL./PALL.	NONE

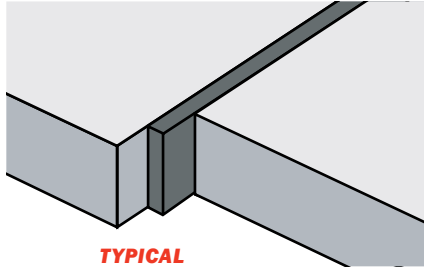

TYPICAL EXPANSION JOINT INSTALLATION

- IDEAL PRODUCT FOR MOST EXPANSION/CONTRACTION JOINT REQUIREMENTS
- EXPANSION JOINT MADE OF WOOD FIBER BONDED TOGETHER WITH AN ASPHALT EMULSION
- EASY TO CUT
- RESILIENT – THIS EXPANSION JOINT WILL RECOVER AT LEAST 70% OF ITS ORIGINAL THICKNESS AFTER COMPRESSION
- MEETS ASTM D-1751 AND AASHTO M-213

FIBRE LITE™ EXPANSION JOINT

SKU	DESCRIPTION	BUNDLE QUANTITY	PALLET QUANTITY	PALLET DEPOSIT
100367	1/2" x 3" FIBERLIGHT EXPANSION JOINT	10 PCS./BNDL.	128 BNDL./PALL.	NONE

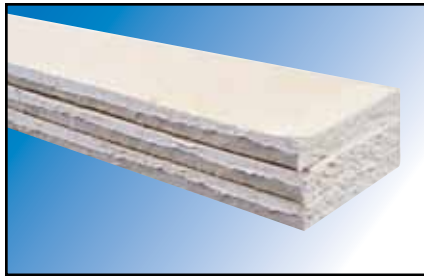

- USED FOR LIGHT DUTY APPLICATIONS
- EXPANSION JOINT FILLER MADE OF 98% RECYCLED PAPER
- RESILIENT AND FLEXIBLE IN ANY TEMPERATURE
- NO BLEEDING OR LEACHING INTO CONCRETE
- NO ASBESTOS, FORMALDEHYDE, OR HARMFUL ADDITIVES
- EASY TO CUT
- V.O.C. COMPLIANT
- MEETS ASTM D-1751 AND AASHTO DESIGNATION M213-65

FOAM EXPANSION JOINT

SKU	DESCRIPTION	QUANTITY	PALLET DEPOSIT
100285	1/4" x 3" x 100' - WHITE	16 ROLLS/BNDL.	NONE
100288	1/2" x 3" x 50' - WHITE	16 ROLLS/BNDL.	NONE
100290	1/4" x 4" x 100' - WHITE	12 ROLLS/BNDL.	NONE
100293	1/2" x 4" x 50' - WHITE	12 ROLLS/BNDL.	NONE



- CLOSED-CELL EXPANSION JOINT FILLER
- IDEAL FOR USE AROUND POOLS
- LIGHTWEIGHT AND FLEXIBLE
- EASILY FORMS TO CURVES
- EASY TO CUT
- CHEMICAL RESISTANT AND ULTRA-VIOLET STABLE
- MEETS ASTM D-1622 AND D-3575

ACCESSORIES

SPEED-E-JOINT

SKU	DESCRIPTION	QUANTITY	PALLET DEPOSIT
100315	1" x 10' SPEED-E-JOINT	50 PCS./CASE	NONE
100321	1-1/2" x 10' SPEED-E-JOINT	50 PCS./CASE	NONE

- **FAST AND EASY-TO-USE PREFORMED CONTRACTION JOINT**
- **PRESS A STRAIGHT EDGE INTO THE WET CEMENT TO PART THE AGGREGATE, THEN PUSH SPEED-E-JOINT INTO PLACE**
- **TOP GRIPPER IS REMOVED ONCE JOINT IS IN PLACE**

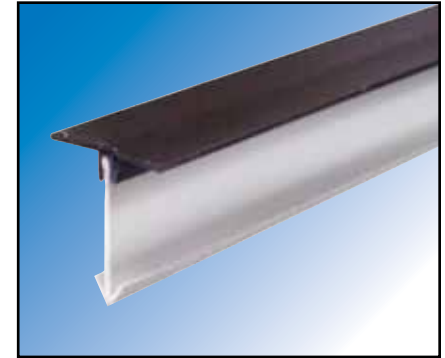

FIBERMESH

SKU	DESCRIPTION	QUANTITY	PALLET DEPOSIT
100652	FIBERMESH CONCRETE REINFORCING - 3/4 LB.	25 BAGS/CASE	NONE

- **POLYPROPYLENE FIBERS THAT ACT AS CONCRETE REINFORCEMENT**
- **MIX DIRECTLY INTO THE WET CONCRETE MIX**
- **MEETS ASTM C-1116, AND C-1116M FOR FIBER REINFORCED CONCRETE**
- **MANUFACTURER RECOMMENDS ADDING 3 LBS. PER YARD OF CONCRETE**

FOR MORE INFORMATION SEE www.fibermesh.com



E-Z SEAL KIT

SKU	DESCRIPTION	QUANTITY	PALLET DEPOSIT
100041	E-Z SEAL KIT - GRAY	4 KITS/CASE	NONE
100043	E-Z SEAL KIT - TAN	4 KITS/CASE	NONE

- **TWO-PART POURABLE, SELF LEVELING SEALANT THAT CURES TO A FLEXIBLE, TEAR RESISTANT RUBBER**
- **IDEAL FOR USE AROUND POOL COPING**
- **WATERPROOF**
- **CHEMICAL RESISTANT**



E-Z SEAL KIT COVERAGE					
JOINT DEPTH	JOINT WIDTH				
	1/4"	3/8"	1/2"	3/4"	1"
1/4"	231'	154'	106'	77'	64'
3/8"	—	102'	77'	51'	38'
1/2"	—	—	64'	38'	29'
3/4"	—	—	—	26'	20'
1"	—	—	—	—	14'

ORDER NOW! 1-800-325-6851

ACCESSORIES



LIQUID NAILS REPAIR MATERIAL

SKU	DESCRIPTION	QUANTITY	PALLET DEPOSIT
160616	CONCRETE AND MORTAR REPAIR – 10.3 OZ.	12 TUBES/CASE	NONE

- **PROVEN, HIGH-QUALITY CONSTRUCTION ADHESIVE**
- **STRONG DURABLE BOND**
- **FILLS CRACKS AND VOIDS**

FOR MORE INFORMATION SEE www.liquidnails.com/ViewProductDetails.do?productId=6

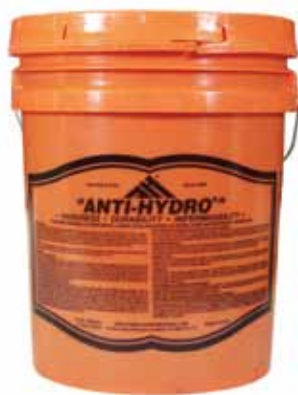

ANTI-HYDRO

SKU	DESCRIPTION	QUANTITY	PALLET DEPOSIT
100542	ANTI-HYDRO – 1 GAL.	6 GALS./CASE	NONE
100545	ANTI-HYDRO – 5 GAL.	36 PAILS/PALLET	NONE

- **ADMIX THAT DRAMATICALLY INCREASES THE STRENGTH AND DENSITY OF CONCRETE, MORTAR, AND GROUT**
- **MIX IN WET CONCRETE – NOT A TOPICAL TREATMENT**
- **MAKES CONCRETE WATERPROOF**
- **FOR STANDARD JOBS, MIX 1 PART ANTI-HYDRO WITH 10 PARTS WATER BY VOLUME, THEN ADD TO CEMENT**
- **ANTI-HYDRO CAN BE USED UNDILUTED WITH FRESH PORTLAND CEMENT FOR “HOT PLUGGING”**
- **NON-CORROSIVE**

FOR MORE INFORMATION SEE www.anti-hydro.com/waterproofing.htm



MURIATIC ACID

SKU	DESCRIPTION	CASE QUANTITY	PALLET QUANTITY	PALLET DEPOSIT
100532	MURIATIC ACID – 1 GAL.	4 BOTTLES/CASE	24 CASES/PALLET	NONE

- **IDEAL FOR CLEANING BRICK AND MASONRY**
- **REMOVES EFFLORESCENCE FROM GROUT AND MORTAR**
- **CONCRETE ETCHING**

WARNING: MURIATIC ACID IS AN IRRITANT; WEAR RUBBER GLOVES AND EYE PROTECTION. AVOID EYE CONTACT OR PROLONGED CONTACT WITH SKIN. IF EYE CONTACT OCCURS, FLUSH WITH WATER FOR 15 MINUTES. CONSULT PHYSICIAN IMMEDIATELY. DO NOT TAKE INTERNALLY.

ACCESSORIES

CALCIUM CHLORIDE

SKU	DESCRIPTION	QUANTITY	PALLET DEPOSIT
100481	CALCIUM CHLORIDE LIQUID - 1 GAL.	4 BOTTLES/CASE	\$10.00
100482	CALCIUM CHLORIDE LIQUID - 5 GAL.	36 PAILS/PALLET	\$10.00
100485	PRILLED CALCIUM CHLORIDE FLAKES - 50 LBS. BAG	56 BAGS/PALLET	NONE

- **MEETS ASTM D-98**
- **LIQUID CALCIUM CHLORIDE IS EASIER TO USE SINCE IT IS ALREADY DISPERSED**
- **PRILLED CALCIUM CHLORIDE IS MORE ECONOMICAL**
- **WHEN MIXED WITH CEMENT IT IMPROVES EARLY STRENGTH GAIN**
- **ACCELERATES CEMENT SET TIME**
- **IMPROVED CEMENT WORKABILITY**
- **PROMOTES EARLIER FORM REMOVAL**
- **ADD 2% CALCIUM CHLORIDE BY WEIGHT OF CEMENT TO YOUR MIXTURE**
- **DUE TO ITS CORROSIVE PROPERTIES, CALCIUM CHLORIDE SHOULD NOT BE USED WITH REINFORCED CONCRETE**

WARNING: CALCIUM CHLORIDE IS AN IRRITANT; WEAR RUBBER GLOVES AND EYE PROTECTION. AVOID EYE CONTACT OR PROLONGED CONTACT WITH SKIN. IF EYE CONTACT OCCURS, FLUSH WITH WATER FOR 15 MINUTES. CONSULT PHYSICIAN IMMEDIATELY. DO NOT TAKE INTERNALLY.



CONCRETE ACCELERATOR

SKU	DESCRIPTION	QUANTITY	PALLET DEPOSIT
100486	CONCRETE ACCELERATOR - 1.5 LBS.	8 BOXES/CASE	NONE
100488	CONCRETE ACCELERATOR - 5 LBS.	4 BOXES/CASE	NONE

- **SPEEDS UP CONCRETE SET TIME**
- **MIX APPROXIMATELY 2.5 LBS. OF ACCELERATOR PER 90 LB. BAG OF CONCRETE MIX**



CONCRETE GLUE

SKU	DESCRIPTION	CASE QUANTITY	PALLET QUANTITY	PALLET DEPOSIT
100466	CONCRETE GLUE - 1 QT.	12 BOTTLES/CASE	—	NONE
100469	CONCRETE GLUE - 1 GAL.	4 BOTTLES/CASE	48 CASES/PALLET	\$10.00
100475	CONCRETE GLUE - 5 GAL.	—	36 PAILS/PALLET	\$10.00

- **BONDS NEW CONCRETE TO OLD**
- **CAN BE USED ON CONCRETE, CINDER BLOCK, STONE, TILE, AND SHEET ROCK**
- **CONCRETE GLUE CAN ALSO BE USED AS AN ADMIX TO CEMENT IMPROVING STRENGTH, FLEXIBILITY AND WATER RESISTANCE**



ORDER NOW! 1-800-325-6851

ACCESSORIES

CONCRETE COLOR BAGS



SKU	DESCRIPTION	QUANTITY	PALLET DEPOSIT
200800	BRICK - 25 LBS.	100 BAGS/PALLET	NONE
200802	BUFF - 25 LBS.	100 BAGS/PALLET	NONE
200804	RED - 25 LBS.	100 BAGS/PALLET	NONE
200806	YELLOW - 25 LBS.	100 BAGS/PALLET	NONE
200808	CANYON - 25 LBS.	100 BAGS/PALLET	NONE
200810	GREEN - 25 LBS.	100 BAGS/PALLET	NONE
200812	TAN - 25 LBS.	100 BAGS/PALLET	NONE
200814	ADOBE - 25 LBS.	100 BAGS/PALLET	NONE
200816	CLAY - 25 LBS.	100 BAGS/PALLET	NONE
200818	BROWN - 25 LBS.	100 BAGS/PALLET	NONE
200820	COFFEE - 25 LBS.	100 BAGS/PALLET	NONE
200822	CHOCOLATE - 25 LBS.	100 BAGS/PALLET	NONE
200824	COCOA - 25 LBS.	100 BAGS/PALLET	NONE
200826	MISSION - 25 LBS.	100 BAGS/PALLET	NONE
200828	BLACK - 25 LBS.	100 BAGS/PALLET	NONE
200830	GOLD - 25 LBS.	100 BAGS/PALLET	NONE
200832	CARBON - 25 LBS.	100 BAGS/PALLET	NONE

CONCRETE AND MORTAR COLOR

THE WEIGHT NEXT TO EACH COLOR REPRESENTS THE AMOUNT OF PIGMENT MIXED WITH EACH 94 LB. BAG OF GRAY CEMENT.

BRICK 1 LB.		BRICK 5 LB.		BROWN 1 LB.		BROWN 5 LB.	
BUFF 1 LB.		BUFF 5 LB.		COFFEE 1 LB.		COFFEE 5 LB.	
RED 1 LB.		RED 5 LB.		CHOCOLATE 1 LB.		CHOCOLATE 5 LB.	
YELLOW 1 LB.		YELLOW 5 LB.		COCOA 1 LB.		COCOA 5 LB.	
CANYON 1 LB.		CANYON 5 LB.		MISSION 1 LB.		MISSION 5 LB.	
GREEN 1 LB.		GREEN 5 LB.		BLACK 1 LB.		BLACK 5 LB.	
TAN 1 LB.		TAN 5 LB.		GOLD 1 LB.		GOLD 5 LB.	
ADOBE 1 LB.		ADOBE 5 LB.		CARBON* 1 LB.		CARBON* 5 LB.	
CLAY 1 LB.		CLAY 5 LB.					

BEST BUILD COLOR	SIMILAR TO DAVIS #
BRICK	160
BUFF	5447
RED	1117
YELLOW	569
CANYON	5084
GREEN	5370
TAN	51127
ADOBE	51126
CLAY	641
BROWN	677
COFFEE	6059
CHOCOLATE	6058
COCOA	6069
MISSION	61205
BLACK	860
GOLD	5237
CARBON	807

Colors shown are as accurate as possible using available methods. The color of the final product is subject to some variation due to differences in materials and workmanship. Always test the pigments with your materials before beginning work to ensure the desired color is achieved.

CONCRETE COLOR

MORTAR COLOR BOXES

SKU	DESCRIPTION	QUANTITY	PALLET DEPOSIT
200702	BRICK - 1 LB.	30 BOXES/CASE	NONE
200704	BRICK - 5 LBS.	5 BOXES/CASE	NONE
200706	BUFF - 1 LB.	30 BOXES/CASE	NONE
200708	BUFF - 5 LBS.	5 BOXES/CASE	NONE
200710	RED - 1 LB.	30 BOXES/CASE	NONE
200712	RED - 5 LBS.	5 BOXES/CASE	NONE
200714	YELLOW - 1 LB.	30 BOXES/CASE	NONE
200716	YELLOW - 5 LBS.	5 BOXES/CASE	NONE
200718	CANYON - 1 LB.	30 BOXES/CASE	NONE
200720	CANYON - 5 LBS.	5 BOXES/CASE	NONE
200722	GREEN - 1 LB.	30 BOXES/CASE	NONE
200724	GREEN - 5 LBS.	5 BOXES/CASE	NONE
200726	TAN - 1 LB.	30 BOXES/CASE	NONE
200728	TAN - 5 LBS.	5 BOXES/CASE	NONE
200730	ADOBE - 1 LB.	30 BOXES/CASE	NONE
200732	ADOBE - 5 LBS.	5 BOXES/CASE	NONE
200734	CLAY - 1 LB.	30 BOXES/CASE	NONE
200736	CLAY - 5 LBS.	5 BOXES/CASE	NONE
200738	BROWN - 1 LB.	30 BOXES/CASE	NONE
200740	BROWN - 5 LBS.	5 BOXES/CASE	NONE
200742	COFFEE - 1 LB.	30 BOXES/CASE	NONE
200744	COFFEE - 5 LBS.	5 BOXES/CASE	NONE
200746	CHOCOLATE - 1 LB.	30 BOXES/CASE	NONE
200748	CHOCOLATE - 5 LBS.	5 BOXES/CASE	NONE
200750	COCOA - 1 LB.	30 BOXES/CASE	NONE
200752	COCOA - 5 LBS.	5 BOXES/CASE	NONE
200754	MISSION - 1 LB.	30 BOXES/CASE	NONE
200756	MISSION - 5 LBS.	5 BOXES/CASE	NONE
200758	BLACK - 1 LB.	30 BOXES/CASE	NONE
200760	BLACK - 5 LBS.	5 BOXES/CASE	NONE
200762	GOLD - 1 LB.	30 BOXES/CASE	NONE
200764	GOLD - 5 LBS.	5 BOXES/CASE	NONE
200766	CARBON - 1 LB.	30 BOXES/CASE	NONE
200768	CARBON - 5 LBS.	5 BOXES/CASE	NONE

- EASY TO USE PRE-MEASURED PACKS
- EXCELLENT PIGMENT DISPERSION
- SUPERIOR COLOR MATCHING FROM BATCH TO BATCH
- 17 COLORS TO CHOOSE FROM
- SOLD BY CASE ONLY



17 COLORS TO CHOOSE FROM!

ORDER NOW! 1-800-325-6851

CONCRETE COLOR

CURING COMPOUND



SKU	DESCRIPTION	QUANTITY	PALLET DEPOSIT
100508	CONCRETE CURE READY-TO-USE (RED) - 5 GAL.4 PAILS/CASE		NONE

- **CURING COMPOUND IS A LIQUID RESIN THAT FORMS A MEMBRANE TO RETAIN THE OPTIMUM AMOUNT OF WATER TO ALLOW COMPLETE HYDRATION OF CEMENT**
- **CURING COMPOUND MEETS ASTM C-309, TYPE I, CLASS B**
- **MAY INTERFERE WITH THE ADHESION OF PAINT, TILE, AND LAMINATE**
- **NON-TOXIC, NON-FLAMMABLE**
- **CONCRETE CURE READY-TO-USE IS A CHEMICALLY REACTIVE LIQUID THAT RETAINS THE OPTIMUM AMOUNT OF WATER TO ALLOW COMPLETE HYDRATION OF CEMENT WITHOUT FORMING A FILM**
- **WILL NOT INTERFERE WITH THE ADHESION OF PAINT, TILE, AND LAMINATE**
- **NON-TOXIC, NON-FLAMMABLE**



FORM OIL

SKU	DESCRIPTION	QUANTITY	PALLET DEPOSIT
100512	FORM OIL - 1 GAL.	4 CANS/CASE	NONE
100518	FORM OIL - 5 GAL.	36 PAILS/PALLET	NONE

- **ELIMINATES CEMENT ADHESION TO WOOD, STEEL, AND PLASTIC FORMS**
- **EASY SPRAY-ON APPLICATION**
- **WATER-BASED FORMULA**

HIGH GLOSS SEALER

SKU	DESCRIPTION	QUANTITY	PALLET DEPOSIT
100554	HIGH GLOSS SEALER - 1 GAL.	4 BOTTLES/CASE	NONE



- **WATER BASED - CALIFORNIA V.O.C. COMPLIANT**
- **COVERS APPROX. 300-500 SQ. FT. PER GALLON**
- **SEALS AND PROTECTS**
- **NON-YELLOWING**
- **RESISTS STAINS**
- **FAST DRYING**

Best Build High-Gloss Sealer not only seals and protects, but also brings out the natural color and beauty of your tile, paving stones, and masonry with a glossy shine.



**SALTILLO
PAVERS**

SLATE

GRANITE

ASPHALT

ASPHALT PATCH

SKU	DESCRIPTION	QUANTITY	PALLET DEPOSIT
090369	ASPHALT PATCH - 60 LBS.	50 BAGS/PALLET	\$10.00

- **IDEAL FOR PATCHING ASPHALT DRIVEWAYS OR PARKING LOTS**
- **GOOD FOR TEMPORARY PATCHING**
- **.55 CU. FT. PER BAG**



ASPHALT PATCH GLUE

SKU	DESCRIPTION	QUANTITY	PALLET DEPOSIT
090372	ASPHALT GLUE - 1 GAL.	4 BOTTLES/CASE	NONE

- **IMPROVES THE BONDING STRENGTH OF NEW ASPHALT TO OLD**
- **COVERS APPROX. 40-50 SQ. FT. PER GALLON**



ORDER NOW! 1-800-325-6851

CAR STOPS



CAR STOPS

SKU	DESCRIPTION	QUANTITY	PALLET DEPOSIT
042335	CAR STOP - 4'	25 PCS./PALLET	\$10.00
042336	CAR STOP - 6'	20 PCS./PALLET	\$10.00

DON'T SETTLE FOR LESS!

- OUR CAR STOPS ARE WET CAST USING 4000 PSI CONCRETE MIX
- LARGE 1" AGGREGATE FOR STRENGTH
- 2 PIECES OF REBAR FOR REINFORCEMENT
- 4' CAR STOP WEIGHS 108 LBS. EACH; 6' CAR STOP WEIGHS 164 LBS. EACH



4 FT. CAR STOP - 108 LBS.

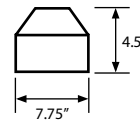
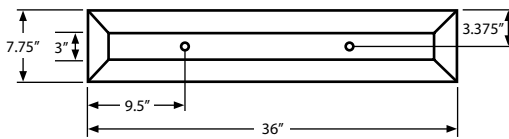

6 FT. CAR STOP - 164 LBS.

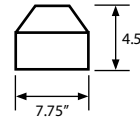
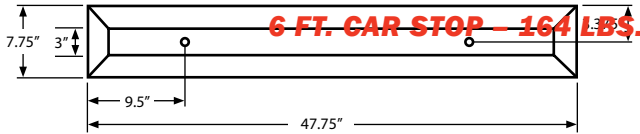

CAR STOP PINS

SKU	DESCRIPTION	QUANTITY	PALLET DEPOSIT
050412	#5 REBAR CAR STOP PINS - 12"	10/BNDL.	\$10.00

- USED TO ANCHOR CONCRETE CAR STOPS IN PLACE
- USE 2 PINS PER CAR STOP